

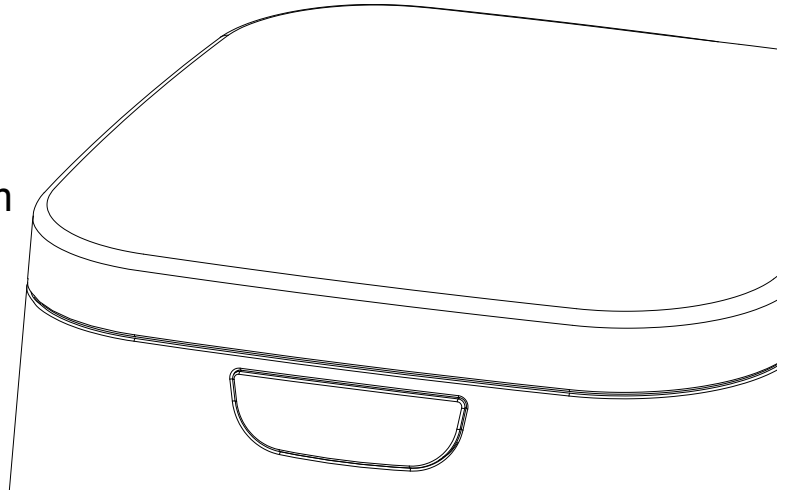

www.TheCPAPShop.com



SoClean.2

PAP Disinfecting Device User Guide

Including all PAP Devices (*Positive Airway Pressure*)
CPAP, VPAP, APAP, BiPAP, BPAP, C-Flex, A-Flex, and Bi-Flex

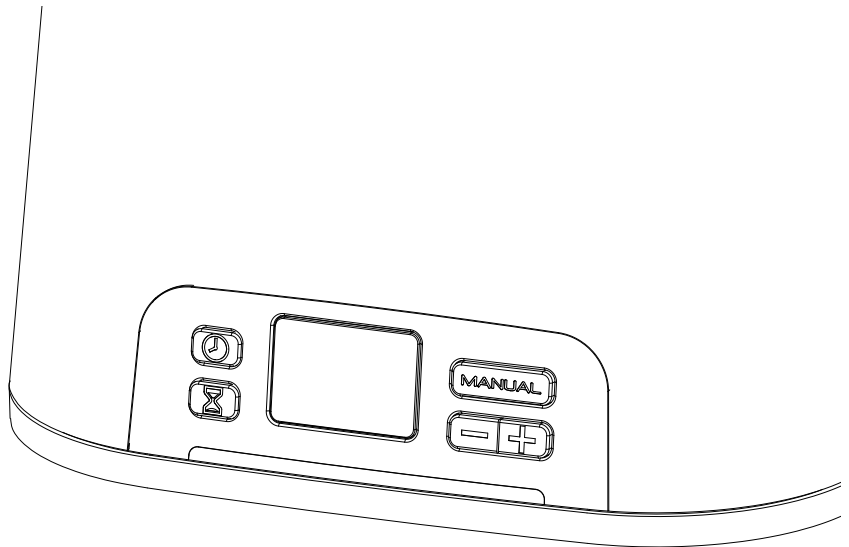

Thank You!

Thank you for your purchase of the SoClean 2 CPAP disinfecting system. At Better Rest Solutions we are committed to providing innovative and safe methods that can improve the health and well-being of our customers. We hope that the SoClean will do just that for you. Please familiarize yourself with this manual, and the operation of the unit. After a few easy steps, you'll find that daily disinfecting of your CPAP equipment has never been easier. This unique process eliminates bacteria, mold, viruses, and other pathogens. It does all this by using gaseous activated oxygen alone – no need for liquid disinfectors or messy preparations. Please feel free to contact us with any questions or concerns you might have.



Contents

1. Indications for Use, Cautions, and Specifications.....	4
3. Included with your SoClean	5
4. Important Supplies	6
5. Getting Started.....	7
6. Your SoClean Timer & Display	10
7. Using your SoClean.....	14
8. Care and Maintenance for your SoClean.....	16
9. FAQ.....	17
10. Classification, Symbols, Tables	18









Indication of Use, Cautions, and Specifications

Indications for Use: The SoClean is a general, Positive Airway Pressure (PAP), disinfecting unit and is intended to be used in the home and professional healthcare facility. A patient who uses Continuous Positive Airway Pressure (CPAP) for Obstructive Sleep Apnea (OSA) treatment can use the SoClean to have a daily automated disinfecter when one fails to follow daily cleaning procedures or wants the added benefit of a thorough disinfecting in addition to daily cleaning.

The SoClean is designed to be attached to a patient's pap machine continuously, while only running when the mask is in the disinfecting chamber.

Contraindications for Use: Do not use SoClean if patient uses fragrant essence in the reservoir water or highly fragrant detergents to clean CPAP equipment.

Discontinue use if patient develops acne or rash along mask contact line.

-  **DANGER:** Keep away from water sources including rain, bathtubs, sinks and pools.
 -  **DANGER:** Keep away from children. It is not a toy!
 -  **DANGER:** Do not use in explosive air environments, near gas vapors, or other flammables, etc.
 -  **DANGER:** Do not place any items on top of SoClean Unit, particularly flammables or ignitable items.
 -  **DANGER:** Never place any living thing (including pets) inside.
 -  **WARNING:** Do not dismantle the SoClean unit.
 -  **WARNING:** Do not run the SoClean for more than 30 minutes consecutively.
 -  **WARNING:** Please be aware that there are sensitive electronics inside the SoClean. If you need to clean your SoClean, wipe with a damp cloth. Do not submerge your SoClean or use any chemical cleaners to clean out the inside of the SoClean chamber.
-

Electrical Characteristics

Frequency Response: 0.48 MHz
CMRR: 38.5 dBuV/m
Power Consumption: 12 VDC
Sampling Rate: 250.9 MHz

Environmental Characteristics

Operating: 10C to 50C
10% to 95% Humidity
Storage: 10C to 50C
10% to 95% Humidity

Physical Characteristics

Dimensions: 7.5"x6.5"x8.5"
Weight: 5.6lbs
Cord Length: 4' 8"

Included with your SoClean

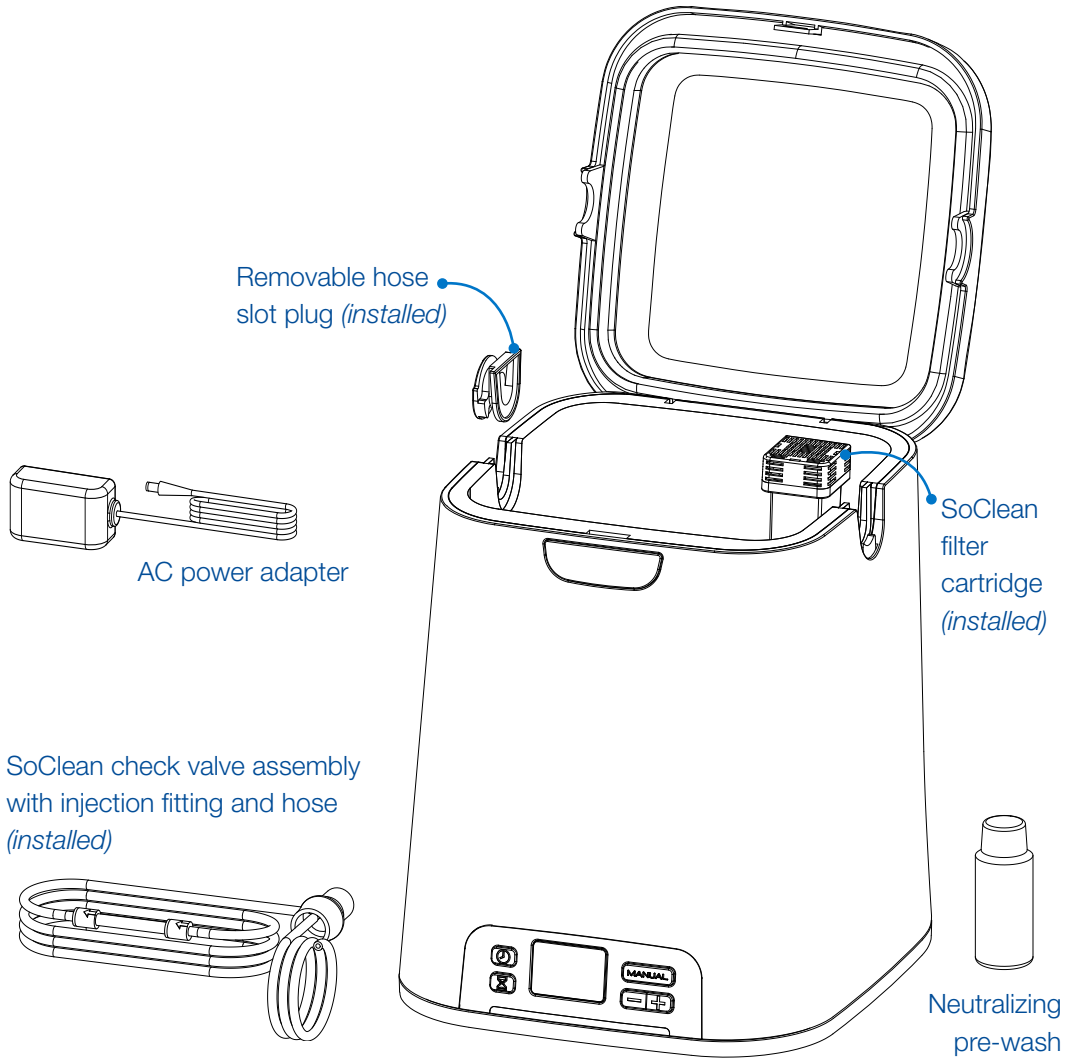

Important supplies

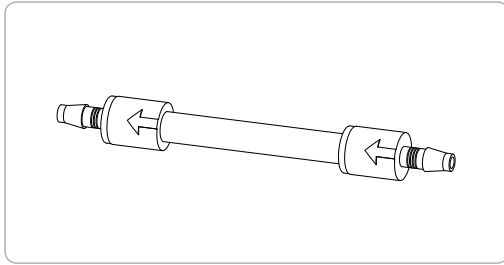

Check Valve Assembly (installed)

Prevents water in your humidifier reservoir from backing up into your SoClean machine. If you can see water in the clear tube, replace the check valve assembly immediately. **Replace every 6 months.**

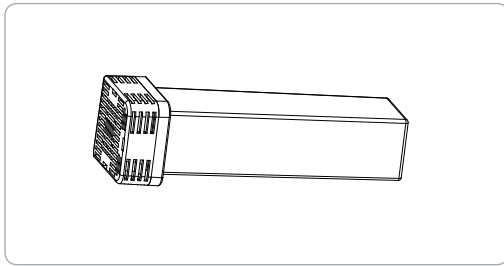

Filter Cartridge (installed)

This filter converts activated oxygen back into normal oxygen. **Replace every 6 months.**



Neutralizing Pre-Wash

Fragrance-free hypoallergenic cleaning solution. The pre-wash neutralizes any pre-existing odors from detergents, and removes any residue from the manufacturing process that could react with activated oxygen. Use the pre-wash whenever you hand wash your CPAP equipment. Use either the pre-wash or any other fragrance-free dye-free dish detergent.

Getting Started

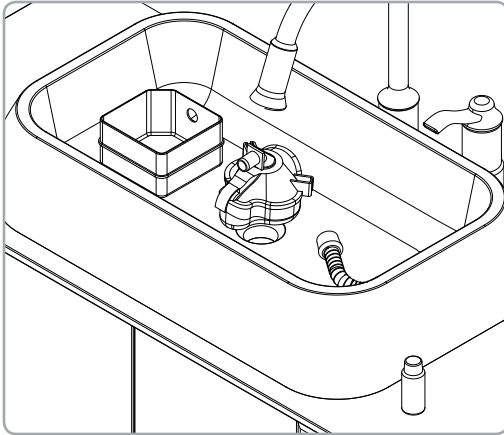

1. Pre-washing your Equipment

Use two capfuls of the included pre-wash with a gallon of water to wash your CPAP equipment (mask, hose, and reservoir), then rinse thoroughly with clean water.

Note: The SoClean 2 Go uses no fluids in its operation. The pre-wash is supplied for hand washing your CPAP equipment only.

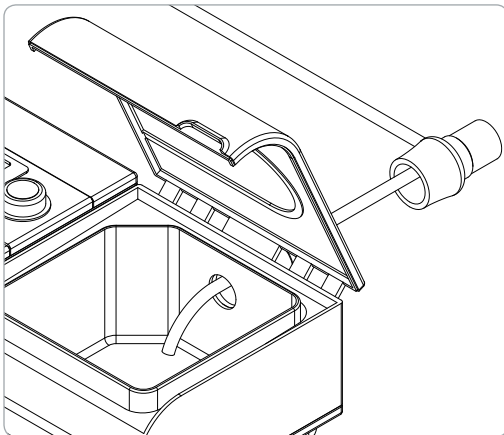

2. Installing the Injection Fitting

With humidifier: Disconnect your CPAP hose from your CPAP machine. Position the injection fitting onto the port of your reservoir, allowing the smaller hose to enter into and rest on or near the bottom of the reservoir. If necessary, trim the injection hose if to fit in the reservoir.

Note: If you keep water in the reservoir, it is recommended to keep the end of the injection hose below the water level.

Getting Started *continued*

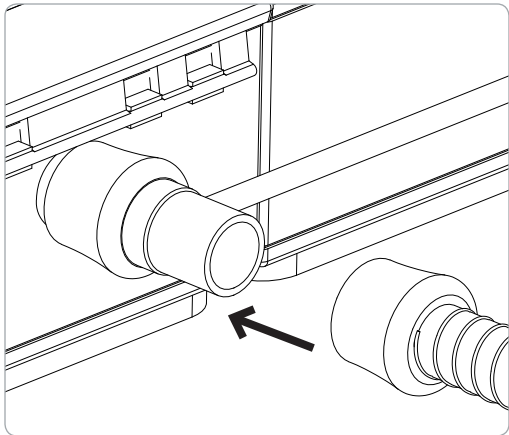

Now connect your CPAP hose to the end of the injection fitting.

Note: Different reservoirs may require different approaches to hose insertion. If you have difficulty, visit www.BetterRestSolutions.com for information on various humidifier models, or contact Better Rest Solutions directly at 1-866-501-3705.

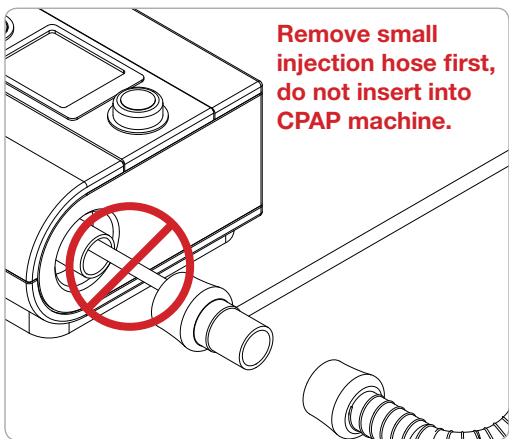

Without humidifier: If you are currently not using a humidifier, remove the short length of black hose from the inside of the injection fitting by pulling it straight off, and then attach the fitting directly to your CPAP machine. Reconnect your CPAP hose to end of the injection fitting.

Note: You do not need to disconnect the injection fitting to use your CPAP. You may leave the SoClean connected to your CPAP.

Depending on the style of your reservoir, you may need to disconnect the fitting to add water to your reservoir.

Getting Started

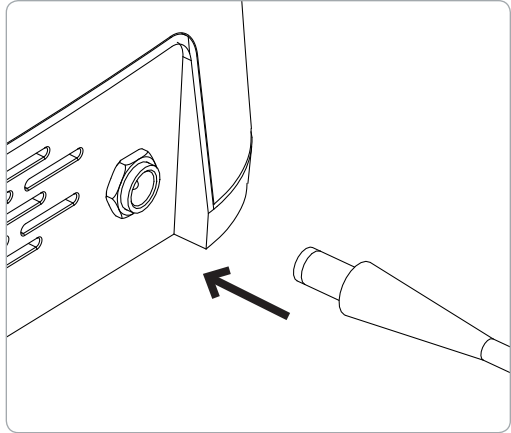
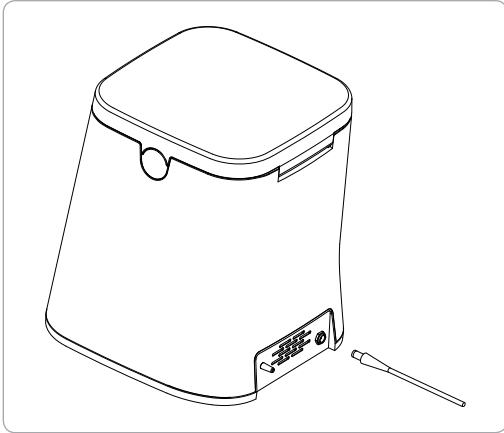
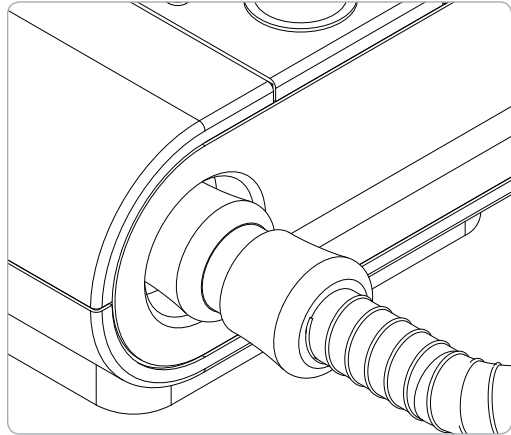
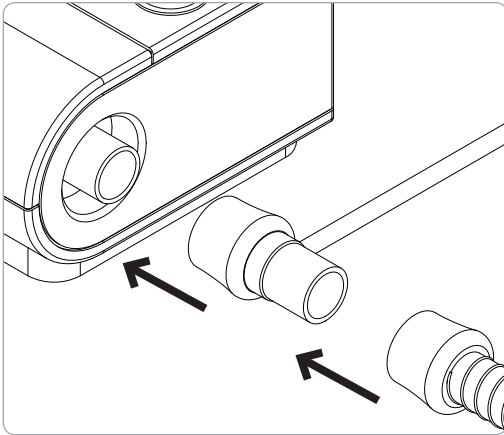

3. Power Up

Plug your AC adapter into the back of the SoClean and then into a wall outlet. Proceed to set your timer.

Your SoClean Timer & Display

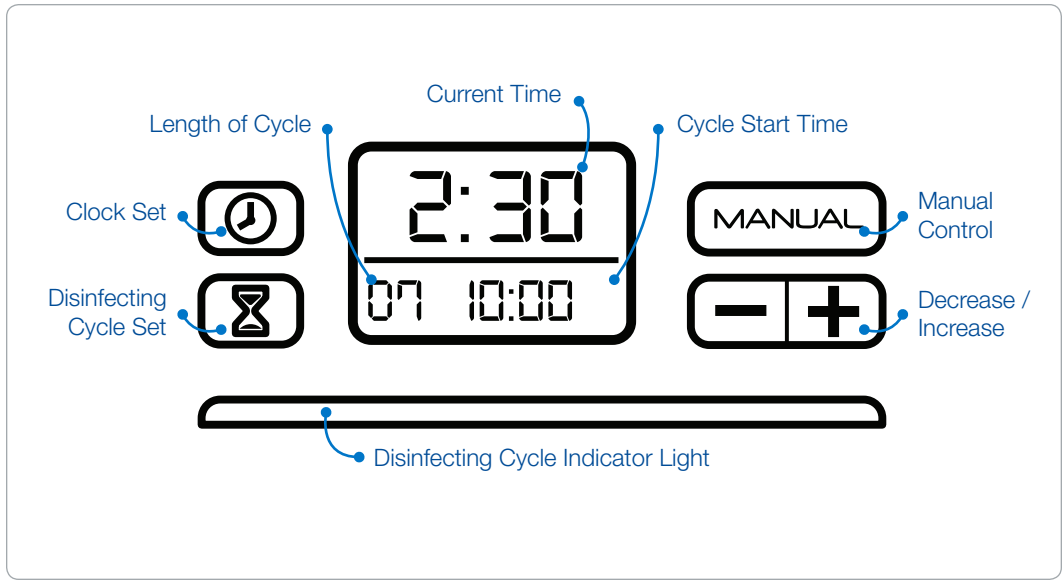

Your SoClean timer will allow you to completely automate your daily cleaning. The SoClean comes preset to start a 7 minute cleaning cycle at 10:00 am. First set the clock to match your current time. You can easily change these settings by following the steps on the next page.

If you unplug the SoClean or experience a power loss, you will need to reset the current time only. The disinfecting settings will remain saved.



Your SoClean Timer & Display



Setting the Clock

Press the  button.



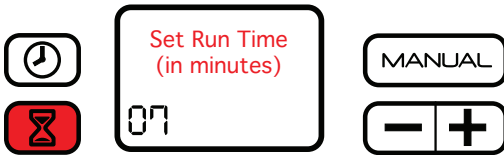

Change the time by pushing either the  or  button until your current time is reached. By holding down the button the time moves faster. Press the  button once more to store your time and return to the home screen.

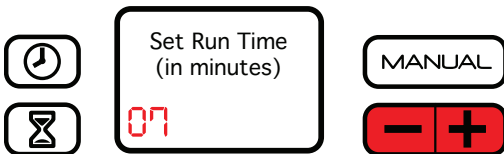

Setting the Run Time and Duration

Press the  button.



Press the  or  button to decrease or increase the number of minutes of your run time.



Note: A run time of 5 to 10 minutes should be enough to completely disinfect your equipment.

Your SoClean Timer & Display *continued*



Press the  button again and you will be prompted to set the time of day you would like to run your SoClean.





Use the  or  button to reach the desired time. Press the  button once more to store your settings and return to the home screen.

Manual Mode

For those times when you wish to sanitize your equipment other than during your scheduled cycle, simply place your mask inside the SoClean like you normally would and press the  button. The SoClean will then operate according to your preset run time. Your timer settings will not be affected. As with your normal disinfecting procedure, wait for the green light before removing your mask.



24-Hour Clock

If you prefer your clock to display in the 24-hour format (military time), press the  and  buttons. You will then be prompted to choose either the 12 or 24-hour format. Press the  button to save your setting.



Your SoClean Timer & Display

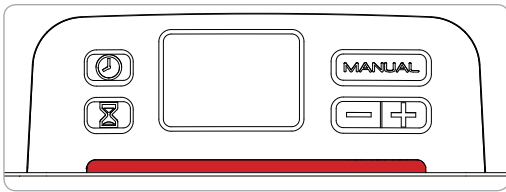

Cycle Indicator Light

The lighted bar below the clock display indicates which stage of the disinfecting cycle the SoClean is in.

RED when the SoClean is operating and generating activated oxygen.



YELLOW when the SoClean is in its 2-hour disinfecting cycle.

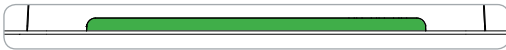

GREEN when disinfecting has been successfully completed.

The lighted display will turn off once the lid is lifted.



Display Messages

Hose not present. Cycle will not run:

This message displays during the manual mode when there is no mask/hose in the SoClean, the lid is not properly closed, or the hose slot plug is missing or improperly seated.

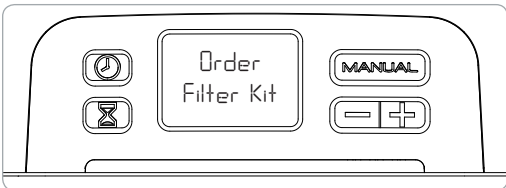

Order filter kit: This message displays after approximately 6 months of use as a reminder to order a replacement filter and check valve kit.

Using Your SoClean

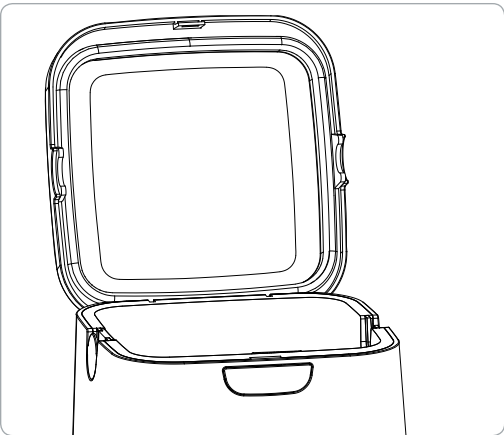
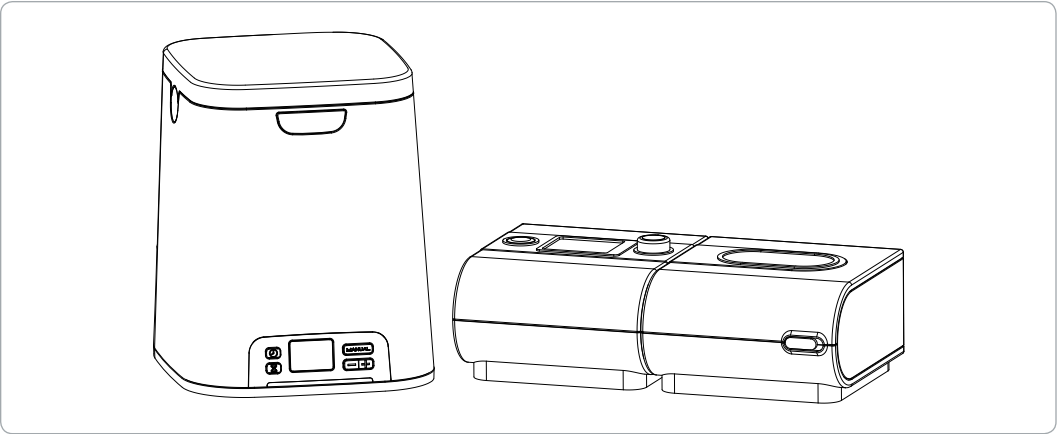

After the initial setup, using your SoClean unit is extremely easy. You will not need to disassemble any components to disinfect your equipment daily.

1. Open the lid.
2. Install the removable hose slot plug into one open slot.

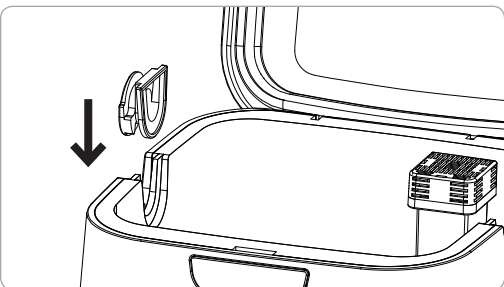

Using Your SoClean

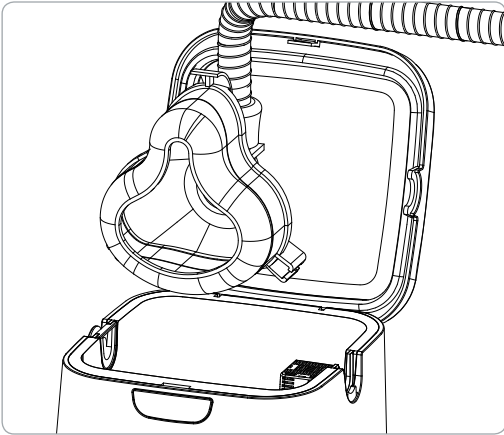

3. Insert your mask into the chamber allowing its attached hose to rest in the open hose slot.

Note: The SoClean gives you the option of inserting your mask and hose from either side of the machine. To change sides, remove the hose slot plug from its position by lifting it straight out, and insert it into the slot on the opposite side.

4. Close the lid.

The SoClean will now automatically operate according to its preset time and duration.

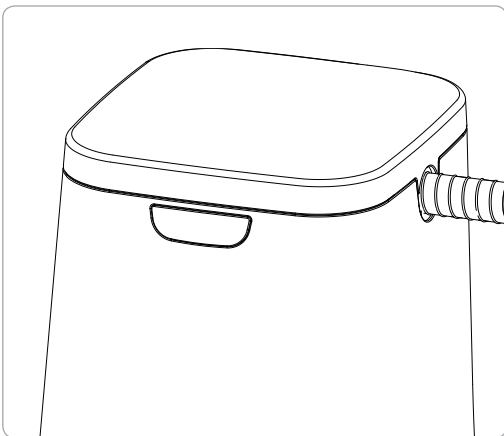

Note: The SoClean will never operate without the mask and hose present in the securely closed chamber. Additionally, the SoClean will not operate if the hose slot plug is missing or improperly seated.

Important: Even though the actual run time of the SoClean may only be 5 to 10 minutes, it is necessary to let the mask remain in the closed chamber for at least 2 more hours. After that period, the cycle indicator light will shine green as a sign that all disinfecting is complete and the mask is ready to be removed from the chamber.

5. Once cycle has completed, open the lid, remove mask and removable hose slot plug. Leave slot plug inside SoClean chamber.

Care and Maintenance for your SoClean

To remove dust, you may wipe down the SoClean with a damp cloth.

The SoClean check valve assembly and filter cartridge should be replaced every 6 months. A reminder message on the display will appear after approximately 6 months, depending upon usage.

Visit www.BetterRestSolutions.com or an authorized distributor to purchase a Cartridge Filter Kit.

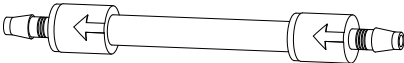
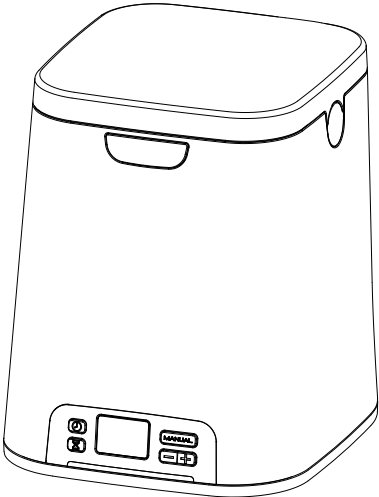

Check Valve Assembly
REPLACE EVERY 6 MONTHS

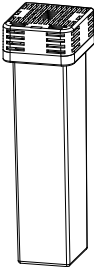

Cartridge Filter
REPLACE EVERY 6 MONTHS

1. Will my CPAP equipment be wet from the SoClean? No. The SoClean disinfects with activated oxygen. No fluids or water are used in this process.

2. Is the SoClean harmful to me or the environment? No. The activated oxygen generator is always kept at a safe level and never reaches the outside environment.

3. How do I know that my SoClean is truly sanitizing? After the disinfecting process has been successfully completed, the cycle indicator light will shine green. Your CPAP equipment will have a light, clean scent.

4. What if the scent the SoClean leaves is too strong for me? If you have already treated your equipment with the Neutralizing Pre-Wash, and still feel that the scent is too strong, there are a number of things you can do: (1) Before wearing your mask at bedtime, run your CPAP for 20 seconds to allow any residual scent to be blown out. (2) Set the timer so that treatments take place earlier in the day, allowing any residual scent to dissipate by nighttime. (3) Reduce the treatment duration time. You can cut back to as little as 5 minutes and still receive effective disinfecting. (4) Disinfect your equipment every other day instead of daily.

5. What if my indicator light is shining red or yellow? This means that the disinfecting process is not yet complete. Please wait until the light shines green to remove your CPAP equipment from the SoClean chamber. (see page 13)

6. What if my indicator light is not shining after a scheduled cleaning time? This would indicate that the SoClean did not carry out its scheduled disinfecting. Common reasons for this are that the lid was not securely closed, there was no mask in the chamber at cleaning time or the open hose slot plug is missing or not properly seated.

7. What if I missed my scheduled sanitizing time, but still wish to sanitize my equipment? In these instances you can use the Manual feature. See your User Guide on how to do this. (see page 12)

8. Why does my display say Order Filter Kit? This message appears approximately every 6 months, depending upon usage, as a reminder to regularly replace the filter and check valve assembly.

9. Are there materials that I should avoid putting into the SoClean? Nylon and natural rubber break down when exposed to activated oxygen. Most manufacturers typically do not use these materials in their reservoirs, hoses, masks or headgear. If you have questions in this regard, contact your CPAP manufacturer, supplier or Better Rest Solutions.

10. My mask feels oily, what should I do? Skin chemistry is unique. Some individuals with an oily skin type may need to hand-wash the mask occasionally.

For further questions or concerns, please feel free to search our website www.betterrestsolutions.com, or contact us at 866-501-3705.

Classification, Symbols, Tables



Consult Manual

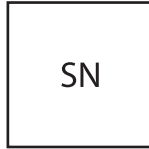

Serial Number

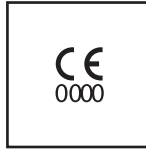

Complies with
Medical Device
Directive of the
European Union.

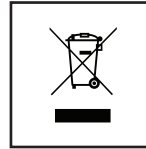

Waste Electrical and Electronic Equipment (WEEE) It is the responsibility of the end user to dispose of this equipment at a designated collection point.

Chomerics Test Services						
Conducted Emissions Class B 150kHz - 30 MHz 9kHz Resolution Bandwidth						
FCC Part 15 Subpart B - Class B - Hot Line - AVERAGE						
Frequency	Neutral Line	Correction	AVG	Margin (dB)	Pass/Fail	Class B
MHz	AVG(dB)	Factor (dB)	dB(uV)	(+/-)	Indicator	Limit
0.47405	2.5	19.9	22.4	-24.4	PASS	47
0.48193	3	19.9	23	-23.5	PASS	47
0.48718	2.3	19.9	22.2	-24.1	PASS	46
0.48928	3	19.9	22.9	-23.4	PASS	46
0.49694	1.8	19.9	21.8	-24.3	PASS	46
0.50266	1.6	19.9	21.6	-24.4	PASS	46
Chomerics Test Services						
Conducted Emissions Class B 150kHz - 30 MHz 9kHz Resolution Bandwidth						
FCC Part 15 Subpart B - Class B - Neutral Line - Quasi Peak						
Frequency	Hot Line	Correction	QP	Margin (dB)	Pass/Fail	Class B
MHz	QP(dB)	Factor (dB)	dB(uV)	(+/-)	Indicator	Limit
0.47405	14.3	19.9	34.2	-22.6	PASS	57
0.48193	14.2	19.9	34.1	-22.4	PASS	57
0.48718	13.9	19.9	33.8	-22.6	PASS	56
0.48928	14	19.9	33.9	-22.4	PASS	56
0.49694	13.5	19.9	33.4	-22.6	PASS	56
0.50266	13.1	19.9	33	-23	PASS	56

Classification, Symbols, Tables

TEST	LOCATION	Measurement Uncertainty (dBuV)
Conducted Emissions 9kHz - 150kHz	Test Chamber A	3.61
Conducted Emissions 150kHz - 30MHz	Test Chamber A	3.23
Radiated Emissions 30MHz - 1GHz at 3 Meter/10 Meter	Open Area Test Site B	4.57
Conducted Emissions 9kHz - 150kHz	Open Area Test Site B	3.61
Conducted Emissions 150kHz - 30MHz	Open Area Test Site B	3.05

Chomerics Test Services - AVERAGE						
Conducted Emissions 150kHz - 30MHz 9kHz Resolutions Bandwidth						
FCC Part 15 Subpart B - Class B - Hot Line - AVERAGE						
Frequency	Hot Line	Correction	AVG	Margin (dB)	Pass/Fail	Class B
MHz	AVG(dB)	Factor (dB)	dB(uV)	(+/-)	Indicator	Limit
0.47583	4.2	19.9	24.2	-22.5	PASS	47
0.47597	4.5	19.9	24.4	-22.2	PASS	47
0.48591	2.8	19.9	22.8	-23.6	PASS	46
0.49005	2.9	19.9	22.9	-23.4	PASS	46
0.49005	2.9	19.9	22.9	-23.4	PASS	46
0.4934	2.6	19.9	22.6	-23.6	PASS	46
Chomerics Test Services						
Conducted Emissions 150kHz - 30MHz 9kHz Resolution Bandwidth						
FCC Part 15 Subpart B - Class B - Hot Line - Quasi Peak						
Frequency	Hot Line	Correction	QP	Margin (dB)	Pass/Fail	Class B
MHz	QP(dB)	Factor (dB)	dB(uV)	(+/-)	Indicator	Limit
0.47583	15.9	19.9	35.8	-20.9	PASS	57
0.47597	15.9	19.9	35.8	-20.9	PASS	57
0.48591	15.1	19.9	35	-21.4	PASS	56
0.49005	14.6	19.9	34.5	-21.8	PASS	56
0.49005	14.6	19.9	34.5	-21.8	PASS	56
0.49005	14.2	19.9	34.1	-22.1	PASS	56

USER GUIDE

**For more information about
SoClean 2
or our other innovative products, please visit
www.betterrestsolutions.com**



JDI ELECTRONICS FACTORY

Sima Industrial Zone, Sima Village, Changping Town
Dongguan City, Guangdong 523570, China



Eumena Ltd.

Eumena Ltd. c/o - Friedrich Schwab
Business Park Dangan, Galway Ireland
Tel. No. 49 173 280 8345

Copyright © 2011-2014 www.betterrestsolutions.com
is a division of Inceptus, Inc.
SoClean™ is a trademark of Inceptus, Inc.
Uxbridge, MA U.S.A. 01569-2001