



ResMed

AirFit™ P10

for AirMini

Nasal pillows system



User guide

English

Fitting / Colocación / Anlegen / Mise en place / Applicazione /
 Opzetten / Tillpassning / Tilpasning / Sovittaminen / Tilpasning /
 Colocación / Colocação / Τοποθέτηση / Takma / Zakładanie /
 Felhelyezés / Fixarea măștii / Установка маски / Paigaldamine /
 الارتداء / Nasazení masky / 配戴 / 配戴 / 装着

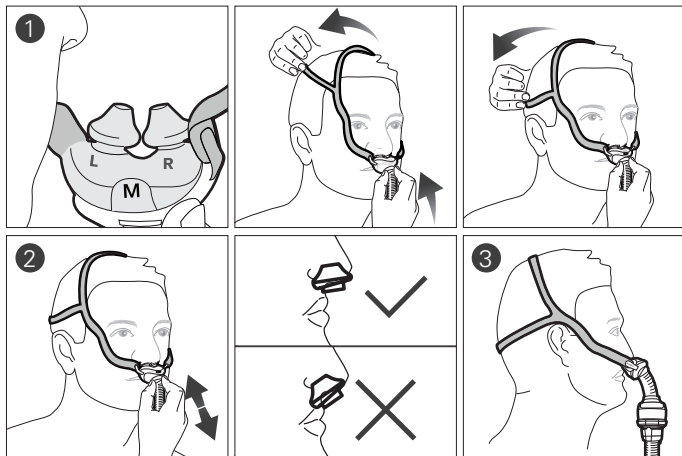

Adjustment / Ajuste / Anpassen / Ajustement / Regolazione /
 Afstellen / Justering / Justering / Säätäminen / Justering / Ajuste /
 Ajuste / Προσαρμογή / Ayarlama / Regulacja / Beállítás / Reglare /
 Регулировка / Kohendamine / الضبط / Úprava masky / 调整 / 調整 /
 調節

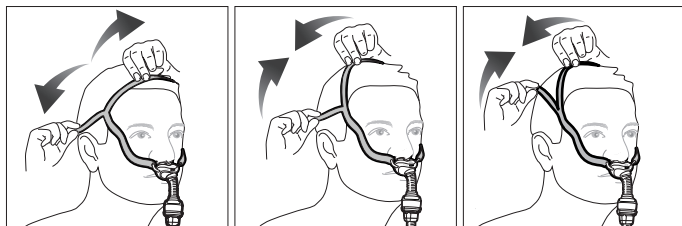

Removal / Remoción / Abnehmen / Retrait / Rimozione / Afnemen /
Borttagning / Fjerning / Pois ottaminen / Fjernelse / Retirada /
Remoção / Αφαίρεση / Çıkarma / Zdejmowanie / Eltávolítás /
Îndepãrtare / Снятие маски / Eemaldamine / النزع / Sejmutí masky /
取下面罩 / 取下面罩 / 取り外し

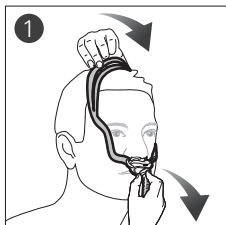

Disassembly / Desmontaje / Auseinanderbau / Démontage /
Smontaggio / Demontieren / Demontering / Demontering /
Maskin purkaminen / Adskillelse / Desmontaje / Desmontagem /
Αποσυναρμολόγηση / Sökme / Demontaž / Szétszerelés /
Dezasamblare / Разборка / Osadeks lahtivõtmine / التفكيك /
Demontáž / 拆卸 / 拆卸 / 分解

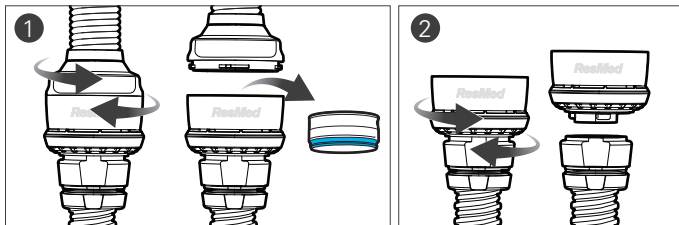

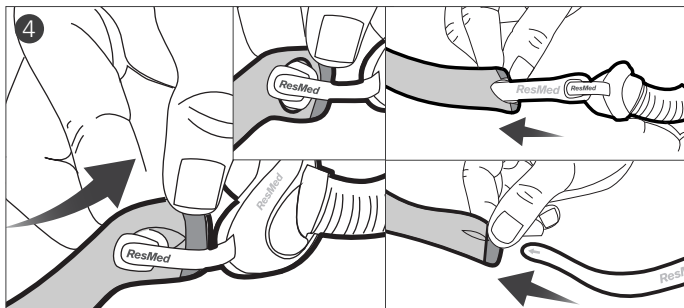
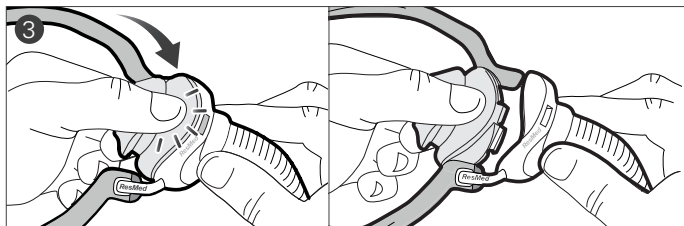

Reassembly / Montaje / Zusammenbau / Remontage /
 Riassetablaggio / Opnieuw monteren / Montering / Montering /
 Maskin kokoaminen / Samling / Nuevo montaje / Nova montagem /
 Επανασυναρμολόγηση / Yeniden montaj / Składanie / Ismételt
 összeszerelés / Reasamblare / Повторная сборка / Uuesti
 kokkupanek / إعادة التجميع / Opřetovné sestavení / 重新组装 / 重新組裝 /
 組立直し

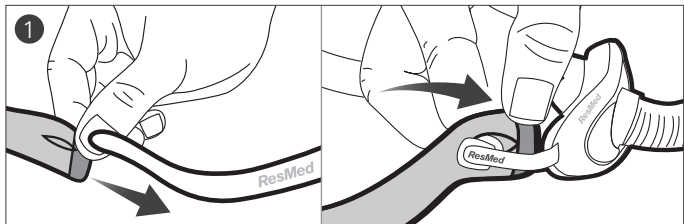

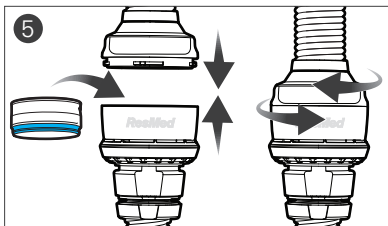
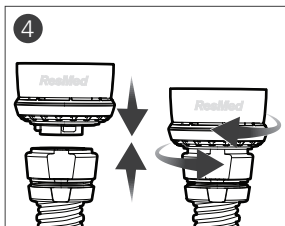
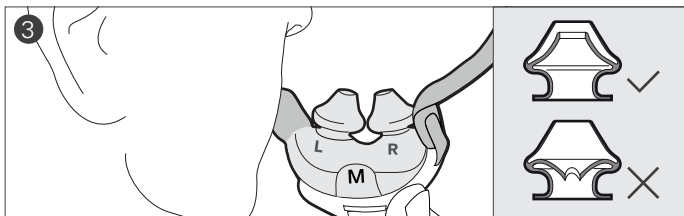
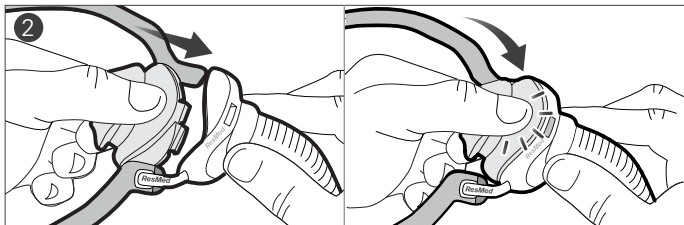
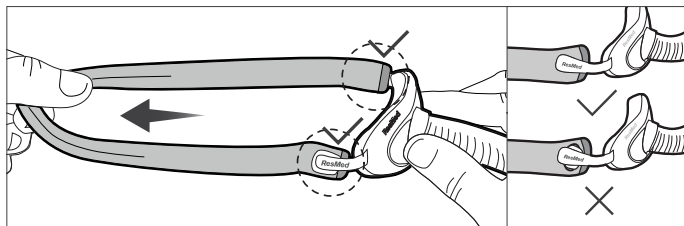

Cleaning the vent / Limpieza del orificio de ventilación /
Luftauslassöffnung reinigen / Nettoyage de l'orifice de
ventilation / Pulizia del dispositivo per l'esalazione / Reinigen
van de ventilatieopening / Rengöra ventilöppningarna / Rengjøre
ventileringsåpningen / Poistoilma-aukon puhdistaminen /
Rengøring af lufthullet / Limpieza de los orificios de ventilación /
Limpeza do respiradouro / Καθαρισμός ανοίγματος εξαερισμού / Hava
deliğini temizleme / Czyszczenie odpowietrznika / A szellőzőnyílás
tisztítása / Curățarea aerisirii / Чистка вентиляционного отверстия /
Ventilatsiooniva puhastamine / تنظيف ثقب التهوية / Čištění ventilačního
otvoru / 清洗通气孔 / 清洗通氣孔 / ベントのクリーニング

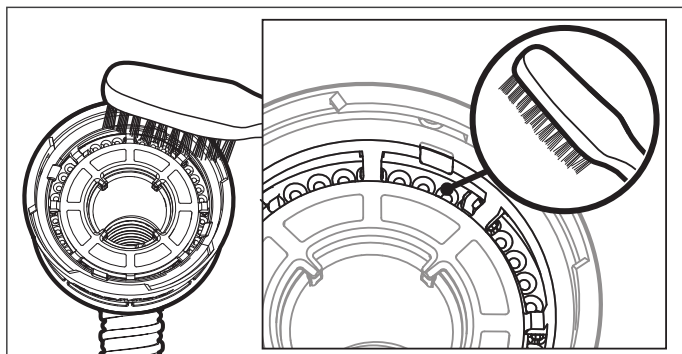

AirFit™ P10

for AirMini

Nasal pillows mask

Thank you for choosing the AirFit P10 for AirMini.

Using this guide

Please read the entire guide before use. When following instructions, refer to the images at the front and back of the guide.

Intended Use

The AirFit P10 for AirMini Mask System is an accessory that is used for channeling airflow to a patient non-invasively. It has custom connecting ports to ensure that it can only be connected to compatible ResMed CPAP devices.

The AirFit P10 for AirMini is:

- to be used by patients >66 lb (30kg) for whom positive airway pressure has been prescribed
- intended for single-patient re-use in the home environment and multi-patient re-use in the hospital/institutional environment.

GENERAL WARNINGS

- The mask must be used under qualified supervision for users who are unable to remove the mask by themselves. The mask may not be suitable for those predisposed to aspiration.
- This mask must only be used with listed compatible therapy device(s) and only as recommended by a physician or respiratory therapist. The AirFit P10 for AirMini requires connection to the listed compatible systems to provide therapy.
- The AirMini system comes with a vent system to prevent carbon dioxide build-up in the mask. The vent system must be kept clean and clear of contamination in order to function correctly. Blocking or modifying the vent system may result in excessive carbon dioxide rebreathing.
- This mask is not for use on patients with impaired laryngeal reflexes or other conditions predisposing to aspiration in the event of regurgitation or vomiting.
- This mask is not compatible with supplemental oxygen.
- Discontinue using this mask if you have ANY adverse reaction to the use of the mask, and consult your physician or sleep therapist.
- Using a mask may cause tooth, gum or jaw soreness or aggravate an existing dental condition. If symptoms occur, consult your physician or dentist.
- As with all masks, some rebreathing may occur.
- Refer to your therapy device manual for details on settings and operational information.
- Remove all packaging before using the mask.
- Avoid connecting flexible PVC products (eg., PVC tubing) directly to any part of the mask. Flexible PVC contains elements that can be detrimental to the materials of the mask, and may cause the components to crack or break.

GENERAL WARNINGS

- The mask should not be used unless the device is turned on. Once the mask is fitted, ensure the device is blowing air. Explanation: CPAP devices are intended to be used with special masks (or connectors) which have vent holes to allow continuous flow of air out of the mask. When the device is turned on and functioning properly, new air from the device flushes the exhaled air out through the mask vent holes. However, when the device is not operating, insufficient fresh air will be provided through the mask, and the exhaled air may be rebreathed. Rebreathing of exhaled air for longer than several minutes can, in some circumstances, lead to suffocation. This applies to most models of CPAP devices.

Using your mask

For a full list of compatible devices for this mask, see the Mask/Device Compatibility List on www.resmed.com/downloads/masks. If you do not have internet access, please contact your ResMed representative.

HumidX and HumidX Plus

The HumidX and HumidX Plus are waterless humidifiers. These are designed to provide more comfort by improving the moisture level in the air you breathe and offering relief from possible dryness.

The HumidX is a good starting point for finding the right level of humidification. The HumidX Plus will improve the humidity level further and is useful when the ambient humidity level is very low (eg. high altitudes, on an aircraft).

The HumidX and HumidX Plus must be replaced within 30 days of opening the HumidX/HumidX Plus pack.

Fitting

To set up your AirMini machine, refer to the AirMini user guide. Once you have set up your AirMini, follow these steps to fit your mask.

1. Align your left (L) and right (R) pillows with your left and right nostrils. Pull the headgear straps over your head. Your lower headgear strap should sit comfortably at the back of your head. The top strap should sit comfortably on your crown.
2. To ensure a comfortable fit, briefly pull your mask away from your nose and reseat the pillows. Ensure the nasal pillows fit securely into your nostrils with both pillows positioned upright.
3. Your mask is now fitted and ready to use. When the device is running, a light breeze should be felt near the venting area around the tube connection. To inspect the vent, place a finger close to the connection area and feel for air. Do not allow the venting area to become blocked.

Adjustment

To achieve a comfortable fit, adjust the upper and lower headgear straps - spread straps apart to loosen or draw closer together to tighten. For additional adjustment, you may use your AirFit P10 Headgear clips. Refer to your Headgear clips instruction sheet for assistance.

WARNING

Do not overtighten the headgear straps

Removal

To take off your mask system, pull the mask and headgear by the split-strap, up and over your head.

Disassembly

1. Disconnect the mask tube from the vent module by gently twisting it and pulling apart. If you are using the HumidX or HumidX Plus, remove it from the vent module.
2. Disconnect the vent module from the AirMini tubing by gently twisting it and pulling apart.

3. Holding the top of the mask tube, squeeze and pull the pillows away from the mask frame.
4. Remove the headgear from the frame by pulling the fabric to reveal each buttonhole, then sliding the fabric off the end of each arm of the frame.

Reassembly

1. With the gray side of the headgear facing out, thread the arms of the mask frame into the buttonholes of the headgear. Secure the headgear by pulling it over the edge of the frame closest to the nasal pillows. Holding the mask frame, stretch the headgear lightly to ensure it is securely attached.
2. Attach the pillows to the mask frame by inserting the top and bottom clips into the correct slots.
3. Ensure the inner walls of the nasal pillows are not compressed or collapsed. If required, a light squeeze can return each nasal pillow to the correct shape.
4. Connect the AirMini tubing to the vent module by pushing the ends together and twisting until it locks in place.
5. To add optional humidification, inset the HumidX/HumidX Plus into the vent module. Connect the mask tube to the vent module by pushing the ends together and twisting until it locks in place.

Cleaning your mask at home

Follow the cleaning instructions in this guide to maintain performance and safety of the mask.

WARNING

- Regularly clean your mask and components to receive optimal therapy and to prevent the growth of germs that can adversely affect your health.
- Do not iron the headgear as the material is heat sensitive and will be damaged.
- Regularly inspect the HumidX/HumidX Plus and follow the cleaning and maintenance instructions to prevent the growth of germs that can adversely affect your health.
- Always follow cleaning instructions and use mild liquid detergent for mask components and mild soap for headgear. Some cleaning products may damage the mask, its parts and their function or leave harmful residual vapors that could be inhaled if not rinsed thoroughly.

Inspect the HumidX/HumidX Plus

1. Check daily for any signs of damage or blockages caused by dirt or dust.

Notes:

- HumidX/HumidX Plus cannot be washed.
- When HumidX/HumidX Plus is not being used, store it in a clean, dry location.
- HumidX/HumidX Plus must be replaced 30 days after opening.

Cleaning the AirMini tube

Refer to your AirMini user guide for cleaning instructions

Cleaning the vent module

1. Clean and check the vent module daily.
2. Wash in warm water using a mild liquid detergent.
3. Clean with a soft bristle brush paying particular attention to the vent holes
4. Rinse well under running water. Shake to remove excess water and allow to air dry out of direct sunlight.
5. Check that there is no dirt or dust in the vent holes.

Note: Do not wash in a dishwasher or washing machine.

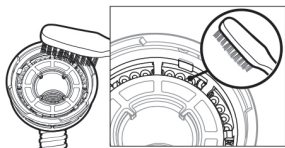

Cleaning the mask pillows, frame and the mask tube

Daily:

1. Clean the mask pillows, frame and mask tube daily. Gently rub in warm (approximately 86°F or 30°C) water using mild liquid detergent until visually clean.
2. Rinse well under running water and allow to air dry out of direct sunlight.

In addition to daily cleaning, each week:

1. Clean the mask frame and the end of the mask tube with mild liquid detergent using a soft bristle brush. Pay particular attention to the crevices and cavities.
2. Rinse well under running water and allow to air dry out of direct sunlight.

Cleaning the headgear

Weekly:

1. Handwash the headgear weekly by gently rubbing in warm (approximately 86°F or 30°C) water using mild soap.
2. Rinse well under running water and allow to air dry out of direct sunlight.

Reprocessing the mask between patients

The Air Mini tube, vent module and HumidX/HumidX Plus must be discarded and replaced with new ones as they cannot be disinfected and should not be used between other patients.

Reprocess this mask when using between patients. Cleaning, disinfection and sterilization instructions are available on www.resmed.com/downloads/masks. If you do not have internet access, please contact your ResMed representative.

CAUTION

Visual criteria for product inspection: If any visible deterioration of a system component is apparent (cracking, discoloration, tears etc), the component should be discarded and replaced.

Troubleshooting

For troubleshooting issues with HumidX/HumidX Plus, refer to the AirMini User Guide.

Problem/possible cause	Solution
Pillows won't seal properly, mask is uncomfortable or causes red marks	
Pillows or headgear may have been fitted incorrectly or adjusted incorrectly.	Check that the nasal pillows with the left (L) and right (R) indicators are inserted correctly. Re-fit your mask according to the fitting instructions. Readjust the headgear to ensure it is fitted comfortably.

Problem/possible cause	Solution
One/both of the pillows are squashed or misshapen or inner wall of one or both pillows is incorrect.	Squeeze individual pillow sides to return each pillow to original shape.
Pillows are the wrong size.	Talk to your clinician.
Pillows may be dirty.	Clean pillows according to the instructions.
Headgear is too loose.	Adjust the headgear straps or use AirFit P10 headgear clips for additional adjustment.
Component appears damaged or worn	Replace the part. Contact your local ResMed dealer.
Mask too noisy	
System is leaking air.	Refit or reposition your mask. Adjust your headgear. Check your mask is assembled correctly.

Technical specifications

Notes:

- The AirFit P10 for AirMini, when connected to the AirMini system, contains a vent system to prevent CO₂ build-up in the mask.
- For technical Specifications related to venting, refer to the AirMini User Guide

Dead Space Information	The physical dead space is the empty volume of the mask up to the compatible tubing connector. Using the large cushions it is 40mL.
Therapy pressure	4 to 20 cm H ₂ O

Environmental conditions	<p>Operating temperature: 41°F to 104°F (+5°C to +40°C) Operating humidity: 10% to 95% non-condensing Storage and transport temperature: -13°F to 158°F (-25°C to +70°C) Storage and transport humidity: 5-95% relative humidity non-condensing</p>
Sound	<p>DECLARED DUAL-NUMBER NOISE EMISSION VALUES in accordance with ISO 4871. The A-weighted sound power level of the mask is 22 dBA, with uncertainty of 3 dBA. The A-weighted sound pressure level of the mask at a distance of 1 m is 15 dBA, with uncertainty of 3 dBA.</p>
Gross dimensions	<p>Large: 6.89" (H) x 5.87" (W) x 1.46" (D) (175 mm (H) x 149 mm (W) x 37 mm (D))</p> <p>Mask frame system (no headgear)</p>
Service Life	<p>The service life of the AirFit P10 for AirMini mask is dependent on the intensity of usage, maintenance, and environmental conditions to which the mask is used or stored. As this mask and its components are modular in nature, it is recommended that the user maintain and inspect it on a regular basis and replace the mask system or any components if deemed necessary or according to the 'visual criteria for product inspection' in the 'Cleaning your mask at home' section of this guide. Refer to the 'Mask components' section of this guide for information of how to order replacement parts.</p> <p>For the Service life of the AirMini tube, vent module and HumidX/HumidX Plus refer to the AirMini device user guide.</p>

Notes:

- The product is not made with PVC, DEHP, DBP or BBP.
- This product is not made with natural rubber latex.
- The manufacturer reserves the right to change these specifications without notice.

Storage

















Ensure that the mask is thoroughly clean and dry before storing it for any length of time. Store the mask in a dry place out of direct sunlight.

Disposal

This mask does not contain any hazardous substances and may be disposed of with your normal household refuse.

Symbols

The following symbols may appear on your product or packaging:

	Catalog number		Batch code
	Humidity limitation		Temperature limitation
	Fragile, handle with care		Do not use if package is damaged
	Manufacturer		European Authorized Representative
	Keep away from rain		This way up
	Nasal Pillows mask		Polypropylene recyclable
	Size - Extra small		Size - Small
	Size - Medium		Size - Large

LATEX?
NOT MADE
WITH NATURAL
RUBBER LATEX

Not made with natural
rubber Latex



Atmospheric pressure limitation



Replace 30 days after opening



Indicates a Warning or Caution and alerts you to a possible injury or explains special measures for the safe and effective use of the device



Caution, consult accompanying documents

R_XOnly

Prescription only (In the US, Federal law restricts these devices to sale by or on the order of a physician)

Limited warranty

ResMed Ltd (hereafter 'ResMed') warrants that your ResMed mask system (including mask frame, cushion, headgear and tubing) shall be free from defects in material and workmanship from the date of purchase for the period of 90 days or in the case of disposable masks the maximum use period. This warranty is only available to the initial consumer. It is not transferable. If the product fails under conditions of normal use, ResMed will repair or replace, at its option, the defective product or any of its components. This limited warranty does not cover: a) any damage caused as a result of improper use, abuse, modification or alteration of the product; b) repairs carried out by any service organization that has not been expressly authorized by ResMed to perform such repairs; and c) any damage or contamination due to cigarette, pipe, cigar or other smoke. Warranty is void on product sold, or resold, outside the region of original purchase.

Warranty claims on defective product must be made by the initial consumer at the point of purchase.

This warranty replaces all other expressed or implied warranties, including any implied warranty of merchantability or fitness for a

particular purpose. Some regions or states do not allow limitations on how long an implied warranty lasts, so the above limitation may not apply to you.

ResMed shall not be responsible for any incidental or consequential damages claimed to have resulted from the sale, installation or use of any ResMed product. Some regions or states do not allow the exclusion or limitation of incidental or consequential damages, so the above limitation may not apply to you. This warranty gives you specific legal rights, and you may also have other rights which vary from region to region. For further information on your warranty rights, contact your local ResMed dealer or ResMed office.

Consumer Warranty

ResMed acknowledges all consumer rights granted under the EU Directive 1999/44/EC and the respective national laws within the EU for products sold within the European Union.

Warranty information for Australian customers

Our goods come with guarantees that cannot be excluded under the Australian Consumer Law. You are entitled to a replacement or refund for a major failure and for compensation for any other reasonably foreseeable loss or damage. You are also entitled to have the goods repaired or replaced if the goods fail to be of acceptable quality and the failure does not amount to a major failure.

In addition to your rights and remedies under Australian Consumer Law (and any other applicable law), ResMed Ltd ABN 30 003 765 142 of 1 Elizabeth Macarthur Drive, Bella Vista NSW 2153 (ResMed) warrants that your ResMed product will be free from defects in material and workmanship from the date of purchase for the period specified below.

Product	Warranty period
<ul style="list-style-type: none">Mask systems (including mask frame, cushion, headgear and tubing)—excluding single-use devicesAccessories—excluding single-use devicesFlex-type finger pulse sensors	90 days

Product	Warranty period
<ul style="list-style-type: none"> Humidifier water tubs (non-reusable) 	
<ul style="list-style-type: none"> Batteries for use in ResMed internal and external battery systems 	6 months
<ul style="list-style-type: none"> Clip-type finger pulse sensors CPAP and bilevel device data modules Oximeters and CPAP and bilevel device oximeter adapters Humidifiers and humidifier water tubs (reusable) Titration control devices ResMed Connectivity Module (RCM) 	1 year
<ul style="list-style-type: none"> CPAP, bilevel and ventilation devices (including integrated humidifiers and external power supply units) Battery accessories Portable diagnostic/screening devices 	2 years

To make a claim under this warranty you should contact the ResMed accredited outlet from which you purchased your ResMed product or send your claim to ResMed at 1 Elizabeth Macarthur Drive, Bella Vista NSW 2153 (phone number (02) 8884 1000) (email: reception@resmed.com.au). All claims under this warranty must be accompanied by your original receipt.

You will then need to deliver the ResMed product you claim is defective to the ResMed accredited outlet from which you purchased your ResMed product or your closest ResMed accredited outlet at your expense. A similar product will normally be lent to you by your ResMed accredited outlet while your product is assessed.

The product you claim as defective must be delivered from the ResMed accredited outlet to the ResMed Service Centre within the relevant warranty period referred to above. ResMed will not be responsible for the cost of the transport of your ResMed product to the ResMed Service Centre. You must pay any necessary costs to the ResMed accredited outlet. If ResMed determines that your warranty claim is

valid, we will return the repaired product, or a replacement product, to your ResMed accredited outlet at ResMed's expense. If ResMed determines that your warranty claim is valid you may claim any reasonable expenses you have incurred in making the claim by posting to us at 1 Elizabeth Macarthur Drive, Bella Vista NSW 2153 a claim in writing attaching original receipts for the expenses claimed. If ResMed determines that your warranty claim is not valid, we will notify your ResMed accredited outlet by providing a quotation of the cost of repair. Your ResMed accredited outlet will then contact you and you will have the option of taking up the quotation offer, valid for 30 days, or have your product returned unrepaired to your ResMed accredited outlet at ResMed's expense.

This manufacturer's warranty is void on product sold, or resold, outside the region of original purchase. Manufacturer's warranty claims on defective product must be made by the initial consumer at the point of purchase or to us directly as specified above.

This warranty gives you specific legal rights. For further information on your warranty rights, contact your local ResMed dealer or ResMed office.

If you are provided with a replacement or repaired product, the warranty continues to apply to the replacement or repaired device but does not continue beyond the original warranty period referred to above.

If you have any questions or would like the address of your nearest ResMed accredited outlet, please contact our friendly customer service consultants.

Mask components / Piezas de la mascarilla / Maskenkomponenten /
 Composants du masque / Componenti della maschera /
 Maskeronderdelen / Maskkomponenter / Maskens komponenter /
 Maskin osat / Maskedele / Piezas de la mascarilla / Componentes
 da máscara / Εξαρτήματα της μάσκας / Maske bileşenleri / Elementy
 maski / A maszk alkatrészei / Componentele măștii / Компоненты
 маски / Maski osad / مكونات القناع / Součásti masky / 面罩组件 /
 面罩組件 / マスク部品

AirFit P10 for
 AirMini

<p>A Headgear / Arnés / Kopfband / Harnais / Copricapo / Hoofdstel Hoofdband / Huvudband / Hodestropper / Pääremmit / Hovedbånd / Arnés / Arnês / Ιμάντες κεφαλής / Başlık / Cześć nagłowna / Fejránt / Suport de cap / Головной фиксатор / Pearihm / غطاء الرأس / Náhlavní souprava / 头带 / 頭帶 / ヘッドギア</p>	<p>62935 62936 (AirFit P10 for her)</p>
<p>1 Split strap headgear / Arnés con correa dividida / Doppelkopfband / Harnais avec sangle à lanière double / Copricapo con cinghia con fenditura / Hoofdstel met dubbele band / Tvådelad huvudbandsrem / Delte hodestropper / Kaksihihnaiset pääremmit / Hovedbånd med splitstrop / Correa doble del arnés / Arnês com correia dividida / Ιμάντες κεφαλής με ρυθμιζόμενα λουράκια / Ayırma bantlı başlık / Cześć nagłowna z podzielonym paskiem / Keresztpántos fejránt / Suport de cap cu curea dublă / Головной фиксатор с разделенным ремешком / Sulgurrihmadega pearihm / غطاء رأس بشرط مشقوق / Náhlavní souprava s pásky s průstřihem / 分开头带 / 分開頭帶 / 分岐ストラップヘ ッドギア</p>	
<p>2 Buttonhole / Ojal / Knopfloch / Boutonnière / Asola / Knoopsgat / Knapphål / Knappehull / Napinreikä / Knaphul/ Ojal / Orificio do botão / Κομπότρυπα / Dügme deliği / Dziurka / Lyuk / Orificiu / Петля / Ava / عروة / Zdiřka / 扣眼 / 扣眼 / ボタンホール</p>	

3 Fabric end / Extremo de tela / Textilende / Extrémité en tissu / Estremità in tessuto / Stoffen uiteinde / Tygände / Tekstilende / Kankaan pää / Stofende / Extremo de tejido / Extremidade de tecido / Άκρη υφάσματος / Kumaş uç / Koniec tkaniny / Szövetvég / Сapăt material / Тканевая лента / Riide ots / طرف النسيج / Textilní dílec / 束帶端 / 束帶端 / ヘッドギア端部

B AirFit P10 headgear clips / Broches del arnés de la AirFit P10 / AirFit P10-Kopfbandclips / Clips d'attache du harnais AirFit P10 / Fermagli del copricapo AirFit P10 / AirFit P10 hoofdbandklemmen / AirFit P10 huvudbandsclips / AirFit P10 hodestroppklemmer / AirFit P10 -päähemmen kiinnikkeet / AirFit P10-hovedbåndsklemmer / Trabas del arnés AirFit P10 / Clipes do arnés da AirFit P10 / Κλιπ ιμάντων κεφαλής AirFit P10 / AirFit P10 başlık klipsleri / Klipsy do części nagłownej AirFit P10 / AirFit P10 fejpántkarcsok / Cleme pentru suport de cap AirFit P10 / Зажимы головного фиксатора AirFit P10 / Maski AirFit P10 pearihma pandlad / AirFit P10 مشابك غطاء الرأس / Spojky náhlavní soupravy AirFit P10 / AirFit P10 头带扣钩 / AirFit P10 頭帶扣鉤 / AirFit P10 ヘッドギアクリップ

62962 (1 pk)
62965 (10 pk)

4 Headgear clip / Broche del arnés / Kopfbandclip / Clip d'attache du harnais / Fermaglio del copricapo / Hoofdbandklem / Huvudbandsclips / Hodestroppklemme / Päähemmen kiinnike / Hovedbåndsklemme / Traba del arnés / Clipes do arnés / Κλιπ ιμάντων κεφαλής / Başlık klipsi / Klipsy części nagłownej / Fejpántkarocs / Cleme pentru suport de cap / Зажим головного фиксатора / Pearihma pannal / مشبك غطاء الرأس / Spojka náhlavní soupravy / 头带扣钩 / 頭帶扣鉤 / ヘッドギアクリップ

C	Pillows / Almohadillas / Polster / Coussins / Cuscinetti/ Kussentjes / Kuddar / Puter / Sieraintyynty/Puder / Almohadillas / Almofadas / Μαξιλάρια / Yastıklar / Wkładki / Párnák / Pernițe / Канюли / Padjad / الوسائد / Polštářky / 鼻枕 / 鼻枕 / ピロークッション	62930 (XS) 62931 (S) 62932 (M) 62933 (L)
5	Nasal Pillows / Almohadillas nasales / Nasenpolster / Coussins narinaires / Cuscinetti nasali / Neuskussentjes / Näskuddar / Neseputer / Sieraintyynty / Næsepuder / Almohadillas nasales / Almofadas Nasais / Πινικά μαξιλαράκια / Burun Yastıkları / Wkładki nosowe / Orrpárnák / Pernițe nazale / Носовые канюли / Ninapadjad / الوسائد الأنفية / Nosní polštářky / 鼻枕 / 鼻枕 / 鼻ピロー	
D	AirFit P10 for AirMini mask pack / Paquete de la mascarilla AirFit P10 for AirMini / AirFit P10 for AirMini Maske / Pack du masque AirFit P10 for AirMini / Confezione cuscinetti nasali AirFit P10 for AirMini / AirFit P10 for AirMini maskerpakket / AirFit P10 for AirMini maskpaket / AirFit P10 for AirMini maskepakke / AirFit P10 for AirMini-maskipakkaus / AirFit P10 for AirMini-maskepakke / Paquete de mascarilla AirFit P10 for AirMini / Pacote da máscara AirFit P10 for AirMini / Συσκευασία μάσκα AirFit P10 for AirMini / AirFit P10 for AirMini maske paketi / Pakiet maski AirFit P10 for AirMini / AirFit P10 for AirMini maszkcsomag / Pacht de mască AirFit P10 for AirMini / Упаковка маски AirFit P10 for AirMini / Maskikomplekt AirFit P10 for AirMini / عبوة قناع AirFit P10 for AirMini / Balení masky AirFit P10 for AirMini / AirFit P10 for AirMini面罩套件 / AirFit P10 for AirMini面罩套件 / AirFit P10 AirMiniマスクパック	38824

E AirFit P10 for AirMini frame / Armazón de la AirFit P10 for AirMini / AirFit P10 for AirMini Rahmen / Entourage rigide AirFit P10 for AirMini / Telaio AirFit P10 for AirMini / AirFit P10 for AirMini frame / AirFit P10 for AirMini maskram / AirFit P10 for AirMini ramme / AirFit P10 for AirMini -runko-osa / AirFit P10 for AirMini-ramme / Armazón de la AirFit P10 for AirMini / Armação da AirFit P10 for AirMini / Πλαίσιο AirFit P10 for AirMini / AirFit P10 for AirMini çerçeve / Ramka nośna maski AirFit P10 for AirMini / AirFit P10 for AirMini keret / Cadru AirFit P10 for AirMini / Κορυς AirFit P10 for AirMini / Maski AirFit P10 for AirMini raam / AirFit P10 for AirMini إطار / Tělo masky AirFit P10 for AirMini / AirFit P10 for AirMini 面罩框 / AirFit P10 for AirMini 面罩框 / AirFit P10 AirMini フレーム

6 Frame arms / Brazos del armazón / Rahmenstützen / Bras de l'entourage rigide / Bracci del telaio / Framearmen / Ramfästen / Rammearmer / Rungon sivukappaleet / Rammearme / Brazos del armazón / Braços da armação / Βραχίονες πλαισίου / Çerçeve kolları / Ramiona ramki / Keretmerezítők / Brațele cadrului / Планки корпуса / Raami toed / ذراعا الإطار / Ramena těla masky / 面罩框支撐臂 / 面罩框支撐臂 / サイドフレーム

7 Node / Saliente / Anschluss / Nœud / Nodo / Кноп / Fäste / Node / Kiinnitysnysträ / Knop / Enganche / Encaixe / Κόμβος / Düğüm / Występ / Rögzítőelem / Nod / Пряжка / Sölm / العقدة / Výtupek / 节点 / 節點 / ピロークリップ

8 Mask Tube / Tubo de la mascarilla / Maskenschlauch / Circuit du masque / Tubo della maschera / Maskerslang / Maskslang / Maskeslange / Maskista lähtevä letku / Maskeslange / Tubo de la mascarilla / Tubagem da máscara / Σωλήνας μάσκας / Maske Hortumu / Rura maski / Maszk csöve / Tubul măștii / Трубка маски / Maski voolik / أنبوب القناة / Trubice masky / 面罩管路 / 面罩管路 / 短チューブ

9	Vent module / Módulo de ventilación / Ausatemöffnungsmoduls / Module de ventilation / Modulo del dispositivo per l'esalazione / Ventilatiemodule / Ventilmodul / Ventilasjonsmodul / Poistoilmamoduuli / Udluftningsmodul / Módulo de ventilación / Módulo do respiradouro / Μονάδα εξαερισμού / Hava deliği modülü / Moduł odpowietrzający / Szellőzőegység / Modul de aerisire / Вентиляционный модуль / Ventilatsioonimoodul / وحدة التهوية / Ventilacíni modul / 通气孔模块 / 通氣孔模組 / ベントモジュール	
10	Air tubing / Tubo de aire / AirMini-Schlauchsystem / Circuit respiratoire / Circuito respiratorio / Luchtslang / Luftslang / Luftslange / Hengitysletku / Luftslange / Tubo de aire / Tubagem de ar / Σωλήνωση αέρα / Hava tüpü / Rura przewodząca powietrze / Levegőt vezető cső / Tuburi de aer / Дыхательный шланг / Õhuvoolik / أنبوب الهواء / Vzduchová trubice / 呼吸管路 / 呼吸管路 / エアチューブ	
F	HumidX (pk / Paqu. de u / Stk. / Paquet de / Cfz da / st. / -pack / -pakning / kpl / Pakke med stk. / Paquete de / unid. / ανά συσκευασία / pk / Opakowanie szt. / darabos csomag / buc. / шт/упак / Pakis / علبة وحدات / Balení po ks / 套 / 套 / 包 (日本ではオプション品))	38809 (3pk) 38810 (6pk)
	HumidX Plus (pk / Paqu. de u / Stk. / Paquet de / Cfz da / st. / -pack / -pakning / kpl / Pakke med stk. / Paquete de / unid. / ανά συσκευασία / pk / Opakowanie szt. / darabos csomag / buc. / шт/упак / Pakis / علبة وحدات / Balení po ks / 套 / 套 / 包 (日本ではオプション品))	38812 (3pk) 38813 (6pk)

- XS: Extra small / Extrapequeña / Extra Small / Extra small / Extra Small / Extra small / Extra small / Extra small / Erittäin pieni / Extra small / Extrapequeña / Extra pequeno / Πολύ μικρό / Ekstra küçük / Rozmiar bardzo mały / Extra kicsi méret / Foarte Mică / Очень маленький / Eriti väike / صغير جدا / extra malá / 加小号 / 加小號 / エクストラスモール
- S: Small / Pequeña / Small / Small / Small / Small / Small / Small / Pieni / Small / Pequeña / Pequeno / Μικρό / Küçük / Rozmiar mały / Kicsi méret / Mică / Маленький / Väike / صغير / malá / 小号 / 小號 / スモール
- M: Medium / Mediana / Medium / Medium / Medium / Medium / Medium / Medium / Keskipikoinen / Medium / Mediana / Médio / Μεσαίο / Orta / Rozmiar średni / Közepes méret / Medie / Средний / Keskmine / وسط / střední / 中号 / 中號 / ミディアム
- L: Large / Grande / Large / Large / Large / Large / Large / Large / Suuri / Large / Grande / Grande / Μεγάλο / Büyük / Rozmiar duży / Nagy méret / Mare / Большой / Suur / كبير / velká / 大号 / 大號 / ラージ



ResMed

AirFit™ P10

for AirMini

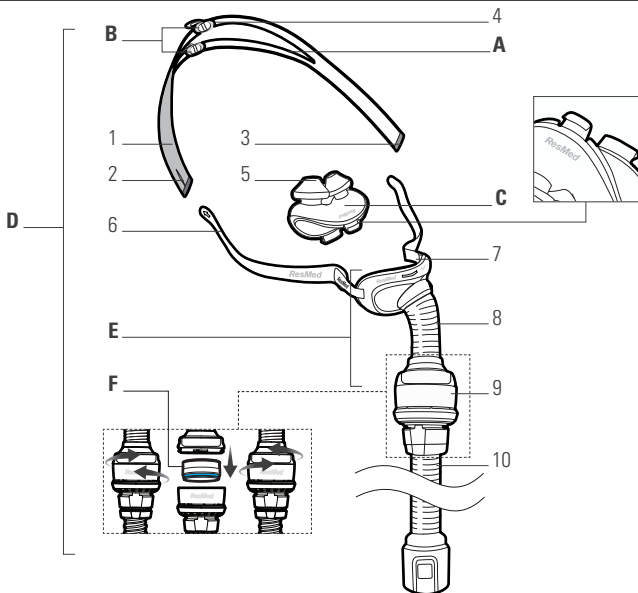

ResMed Ltd

MANUFACTURER

1 Elizabeth Macarthur Drive Bella Vista NSW 2153 Australia

See ResMed.com for other ResMed locations worldwide. AirFit, AirMini and HumidX are trademarks and/or registered trademarks of the ResMed family of companies. For patent and other intellectual property information, see ResMed.com/ip. © 2017 ResMed Ltd. 628128/2 2017-10

ResMed.com

CE 0123



628128